



+60 años al cuidado de tu ropa



www.cuncial.es



+60 años al cuidado de tu ropa

Cuncial TZ lleva más de 60 años dedicada al cuidado de la ropa, especializándose progresivamente en conseguir amplia gama de productos de calidad destinados a cubrir todas tus necesidades de tendido de ropa, lavado, planchado y ordenación, adaptada siempre a las necesidades actuales del consumidor.

Descubre lo que los hogares de hoy demandan y lo que Cuncial TZ es capaz de satisfacer.

Cuncial TZ has been dedicated to clothing care for more than 60 years. Specializing in achieving a wide range of quality products to cover all your needs for laundry, washing, ironing and ordering, always adapting to today's customer.

Discover what today's homes demand and what Cuncial TZ is capable of satisfying.

INDICE/INDEX

Tendido/Drying

Plegables	4
Radiador-Baño	12
Terraza-Balcón	18
Avión	20
Automáticos	22
Acordeón	25
Pinzas	29
Complementos de tendido	31

Planchado/Ironing

Tablas de planchar	33
Complementos de planchado	37

Complementos de lavado/Washing accessories

Sacos y mallas	41
Fundas	42

Ordenación/Home storage

Armarios-Percheros	43
Colgadores	44
Organizadores	45
Zapateros-Hormas	46
Perchas	47

Menaje/Kitchen

Botelleros	51
Cestos	52

Iconografía / Key index

Key index	54
-----------	----

P-2/A Inox-V6mm

REF.: 301041

ACERO INOXIDABLE / STAINLESS STEEL

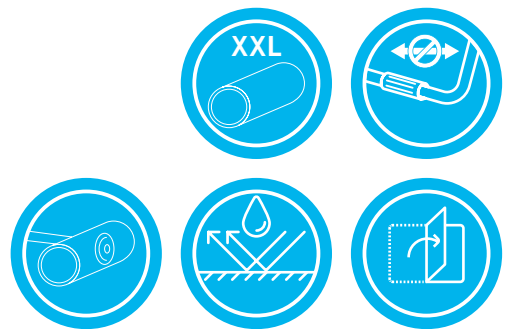

TENDIDO / DRYING

P-2/A Inox extra

REF.: 301004

ACERO INOXIDABLE / STAINLESS STEEL

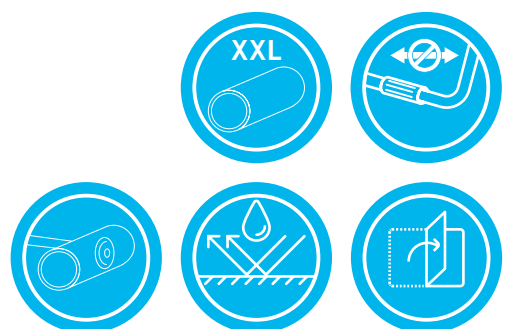

	REF.	EAN	Ⓜ	Ⓜ
P-2/A Inox-V6	301041	8412585001808	166x55x95 cm	6
P-2/A Inox Extra	301004	8412585000382	168x55x95 cm	6

P-2/A Inox Luxe

REF.: 301005

ACERO INOXIDABLE / STAINLESS STEEL

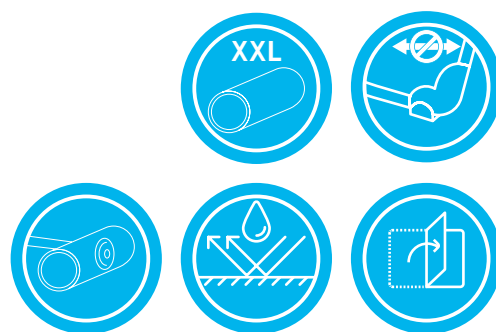

TENDIDO/DRYING



	REF.	EAN		
P-2/A Inox Luxe	301005	8412585000818	168x55x96 cm	6

P-2/A Aluminio

REF.: 301027

ALUMINIO ANODIZADO / ALUMINIUM

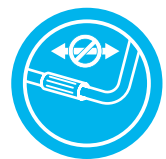
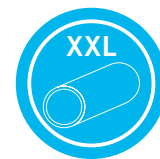

P-2/A Canarias Aluminio

REF.: 301026

ALUMINIO ANODIZADO / ALUMINIUM

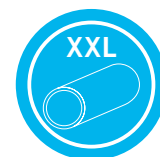

TENDIDO/DRYING

	REF.	EAN	Ⓜ	Ⓜ
P-2/A Aluminio	301027	8412585000238	168x55x95 cm	6
P-2/A Canarias Aluminio	301026	8412585000399	105x55x95 cm	6

P-2/A Canarias COLORS

REF.: 301044

ALUMINIO ANODIZADO / ALUMINIUM

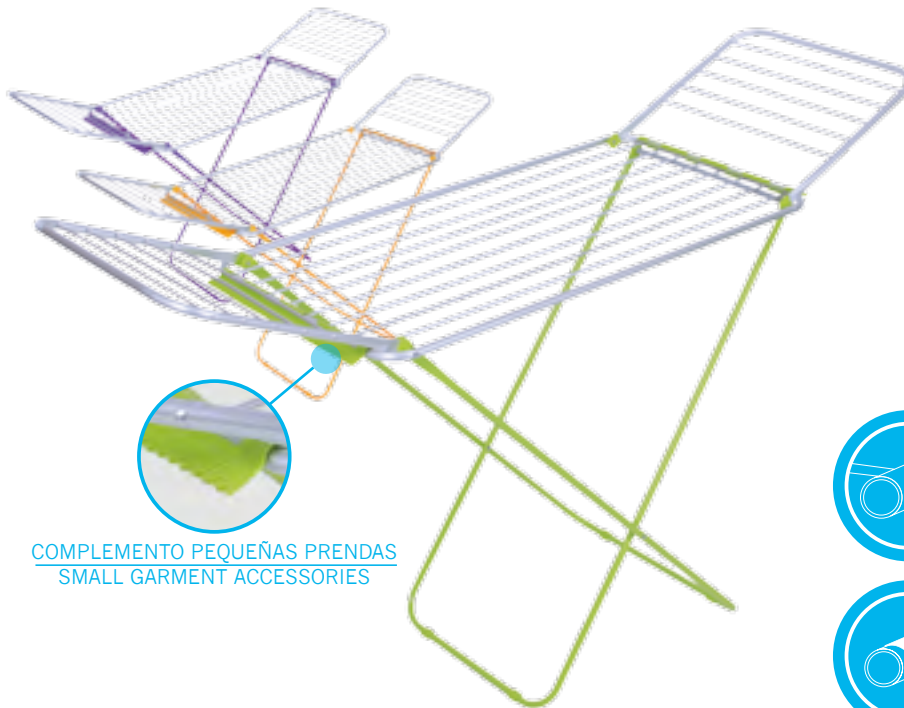

COMPLEMENTO PEQUEÑAS PRENDAS
 SMALL GARMENT ACCESSORIES



COLOR OPTIONS

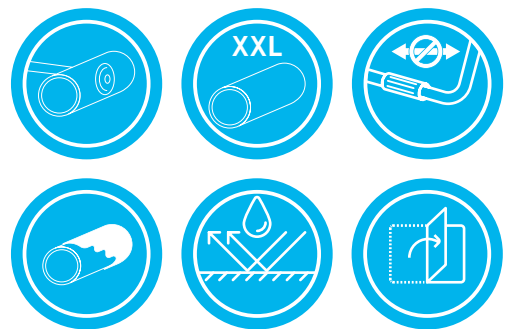

TENDIDO/DRYING

P-2/S Canarias

REF.: 301037

ALUMINIO ANODIZADO / ALUMINIUM

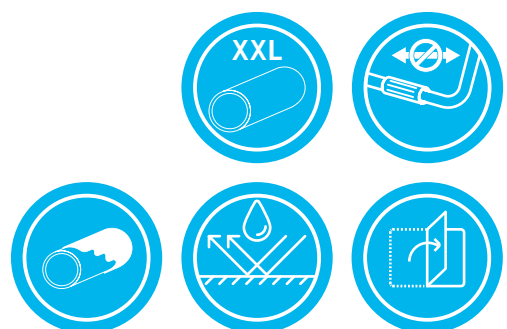

	REF.	EAN	Ⓜ	Ⓜ
P-2/A Canarias COLORS	301044	8412585002676	168x55x95 cm	6
P-2/S Canarias	301037	8412585000665	105x55x95 cm	6

P-2/A Resina

REF.: 301022
RESINA / RESIN



TENDIDO / DRYING

Resina compact

REF.: 301045
RESINA / RESIN

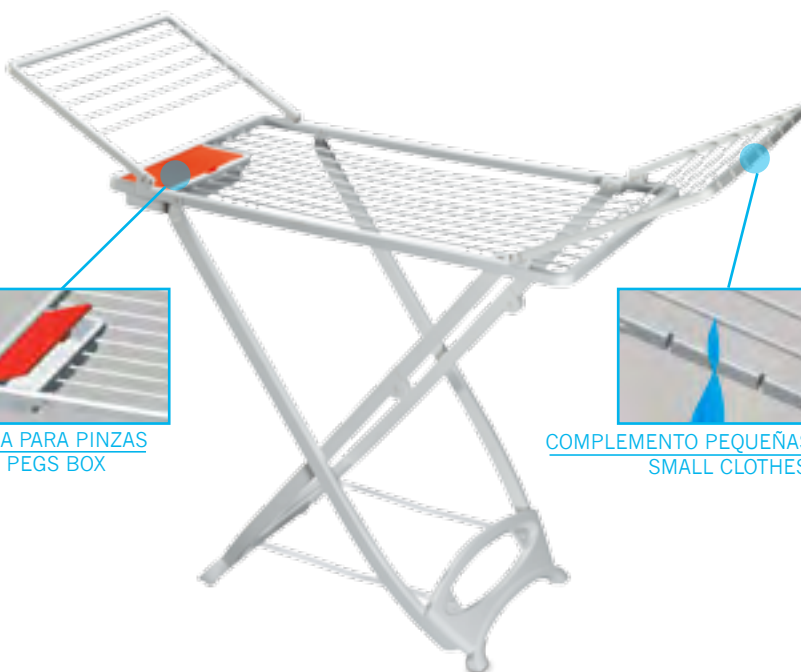



CAJA PARA PINZAS
PEGS BOX



COMPLEMENTO PEQUEÑAS PRENDAS
SMALL CLOTHES



	REF.	EAN		
P-2/A Resina	301022	8412585000429	182x55x88 cm	2
Resina compact	301045	8412585002690	143x53x83 cm	2

Tucán

REF.: 301057
ACERO / STEEL

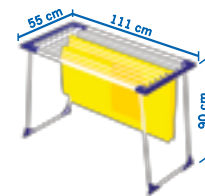
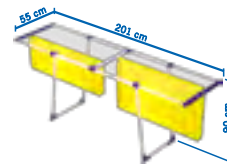
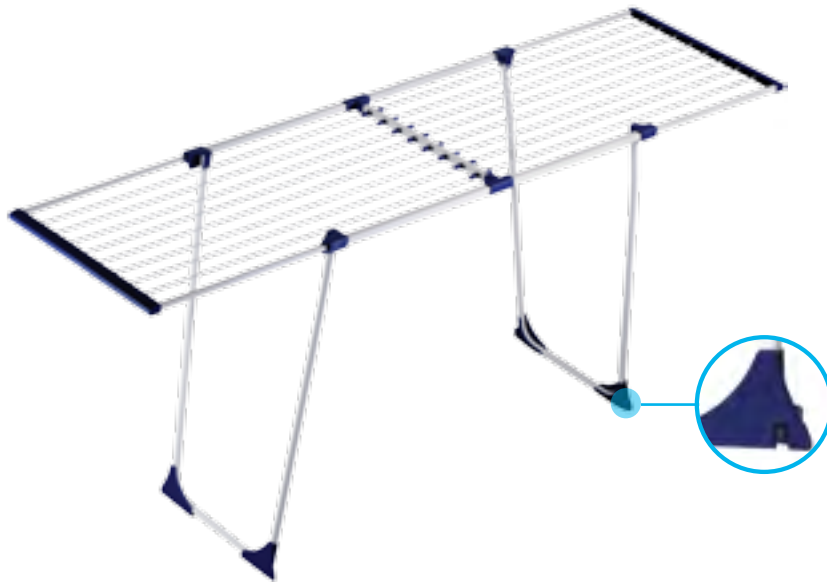

TENDIDO / DRYING

Prometeo

REF.: 301056
ACERO / STEEL



	REF.	EAN	Ⓜ	📦
Tucán	301057	8412585002874	111-201x55x90cm	4
Prometeo	301056	8412585002867	158x43x75 cm	4

P-2/A Capry

REF.: 301050

ACERO / STEEL



P-2/A Básico

REF.: 301007

ACERO/ STEEL

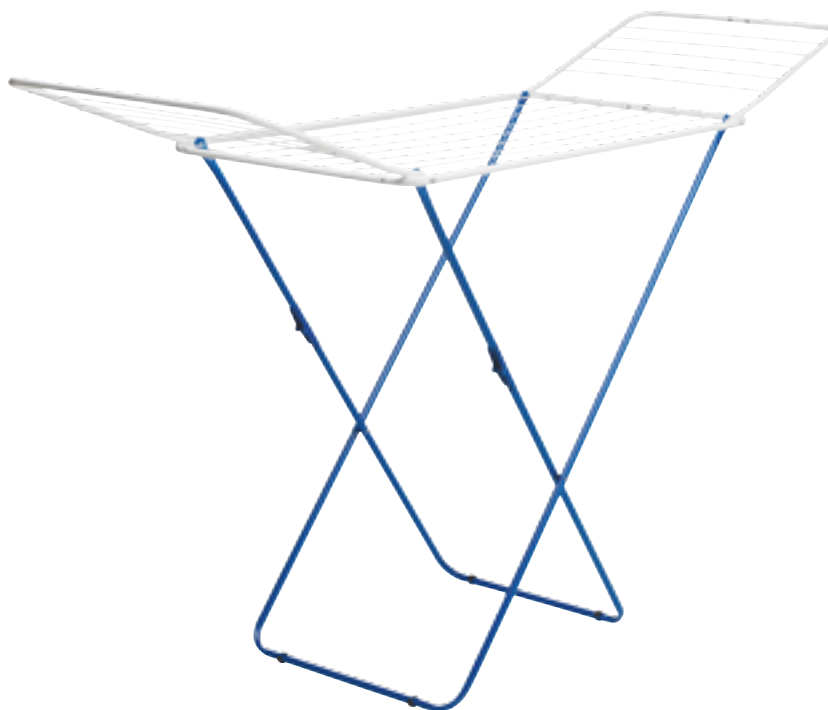

TENDIDO/DRYING

	REF.	EAN	Ⓜ	Ⓜ
P-2/A Capry	301050	8412585000955	180x44x96 cm	6
P-2/A Básico	301007	8412585000573	180x55x96 cm	6

P-2/A Extra

REF.: 301006

ACERO / STEEL



TENDIDO / DRYING

Torre-3

REF.: 301003

ACERO / STEEL

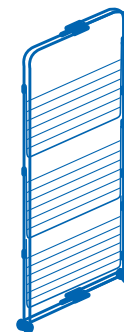
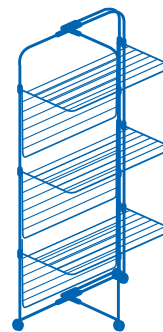
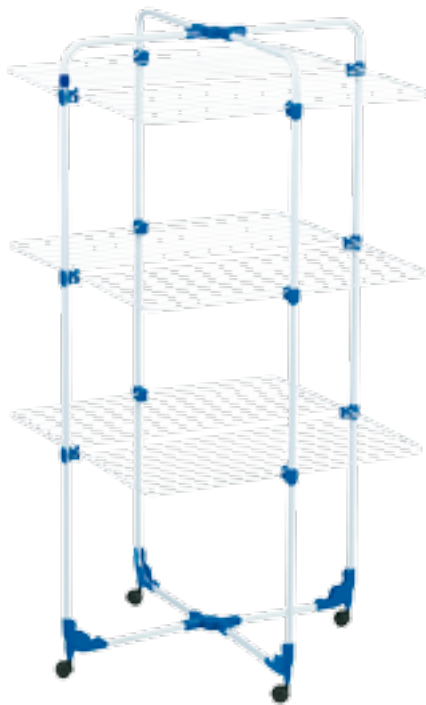

	REF.	EAN	Ⓜ	Ⓜ
P-2/A Extra	301006	8412585001792	180x55x96 cm	6
Torre-3	301003	8412585001822	68x68x130 cm	4

Terraza

REF.: 301008

ACERO / STEEL



Terraza aluminio

REF.: 301010

ALUMINIO / ALUMINIUM

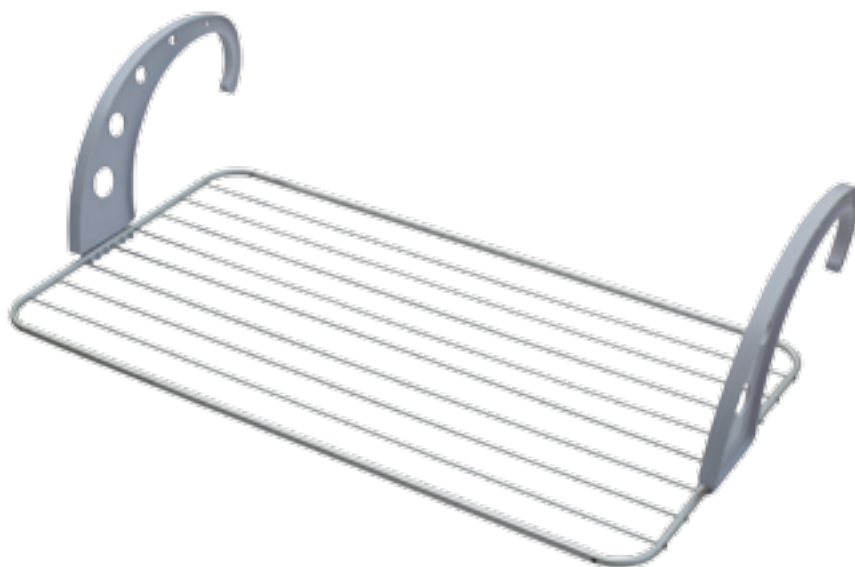

	REF.	EAN	Ⓜ	📦
Terraza	301008	8412585000436	105x55x23,5 cm	6
Terraza aluminio	301010	8412585000634	105x55x23,5 cm	6

TENDIDO / DRYING

Radiador tubo

REF.: 301009

ACERO / STEEL

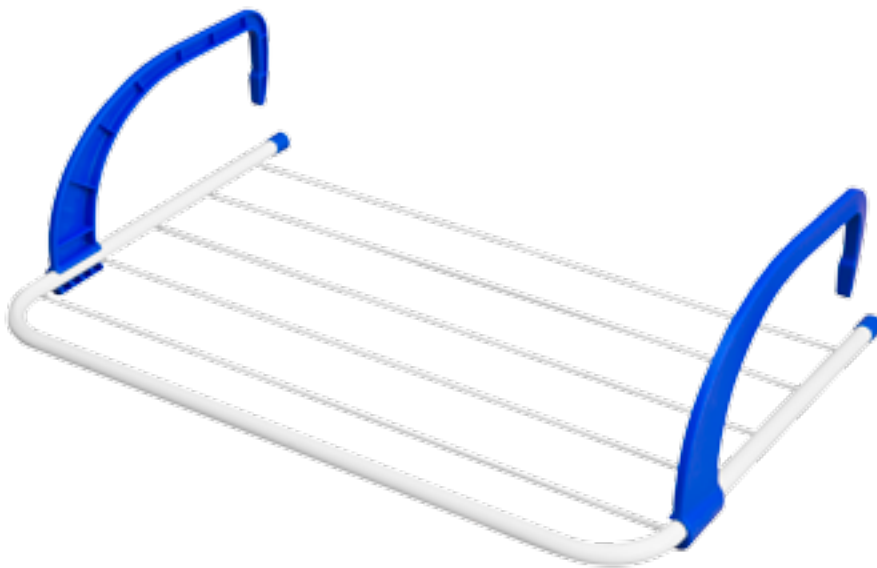

TENDIDO / DRYING

Radiador alambre

REF.: 301014

ACERO / STEEL

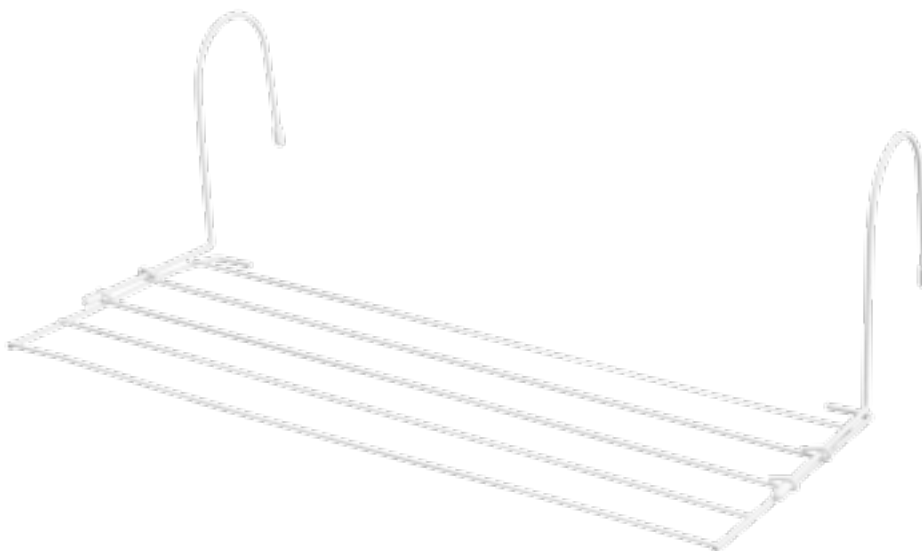

	REF.	EAN	Ⓜ	Ⓜ
Rariador tubo	301009	8412585001839	52x34x13 cm	15
Radiador alambre	301014	8412585000122	51x21x16 cm	15

Multiusos

REF.: 301035

ACERO / STEEL

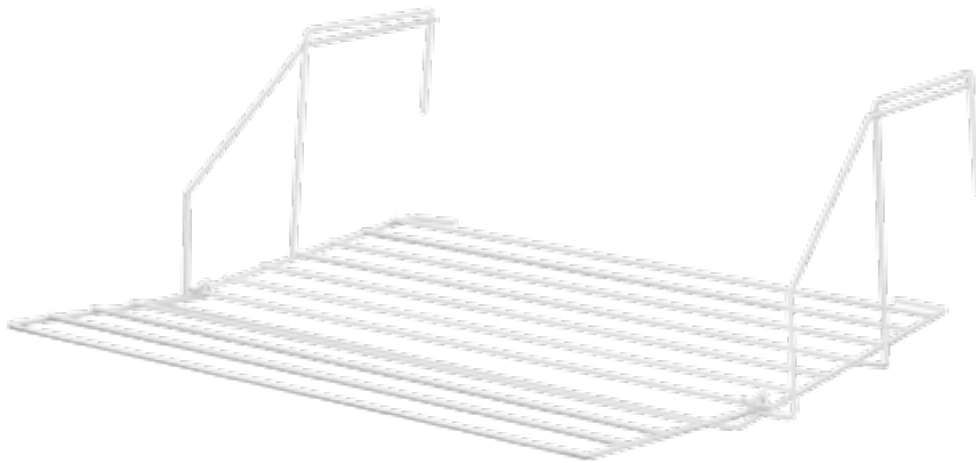

Radiador resina

REF.: 301047

RESINA / RESIN



TENDIDO / DRYING

	REF.	EAN	Ⓜ	Ⓜ
Multiusos	301035	8412585000894	60x58x22 cm	6
Radiador resina	301047	8412585002713	53x35x18 cm	6

Telepack-70

REF.: 301020

RESINA-ALUMINIO / RESIN-ALUMINIUM



TENDIDO / DRYING

Telestar

ABS / ABS

70 71x37cm
REF.: 301042



100 101x52cm
REF.: 301043

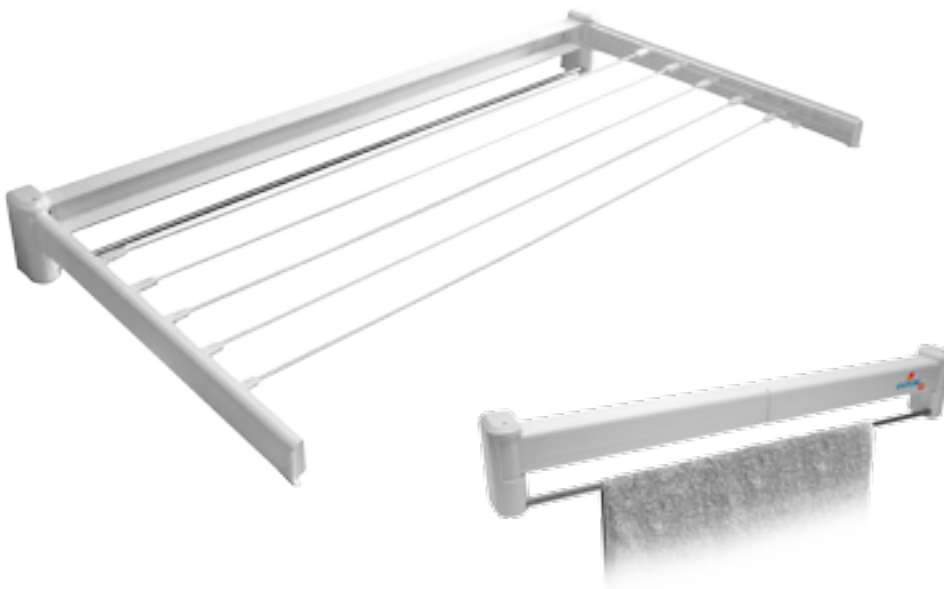

	REF.	EAN	Ⓜ	Ⓜ
Telepack-70	301020	8412585000405	70x39 cm	6
Telestar-70	301042	8412585001853	71,3x37x11 cm	6
Telestar-100	301043	8412585001877	101x52x11 cm	6

Ropa delicada

REF.: 701006
 TEXTIL / TEXTILE

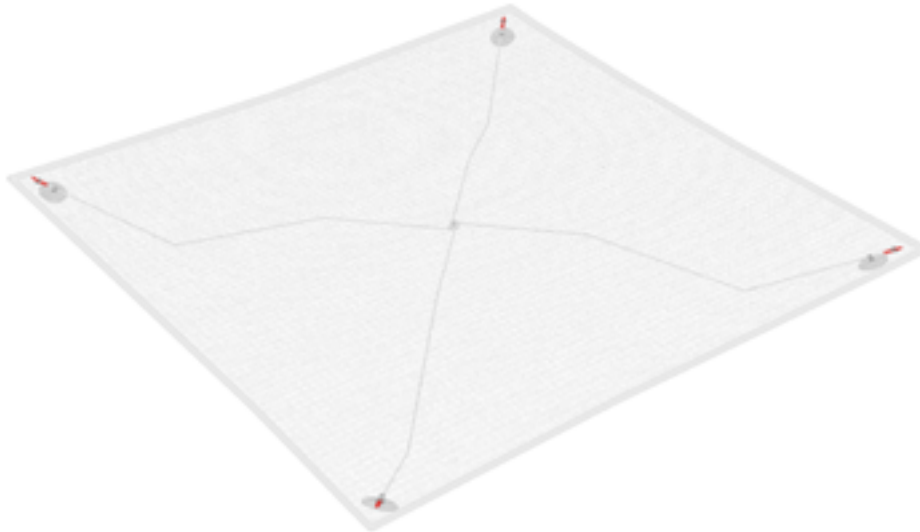

TENDIDO / DRYING

Bañera

REF.: 301040
 ACERO / STEEL

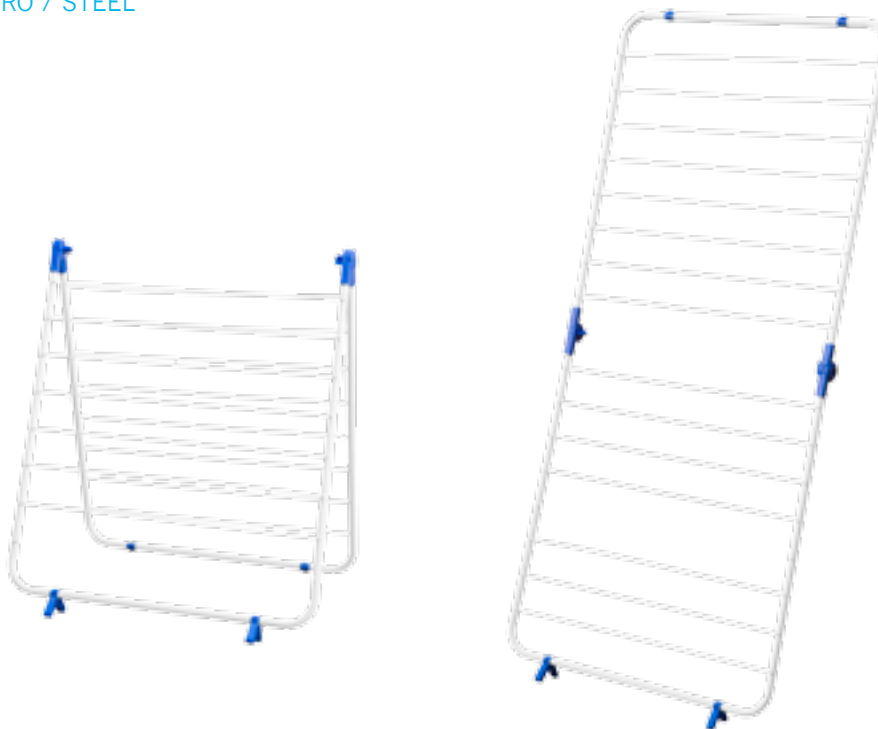

	REF.	EAN	Ⓜ	Ⓜ
Ropa delicada	701006	8412585001051	180x65 cm	12
Bañera	301040	8412585001815	130x65 cm	6

Mural epoxi

REF.: 301011
ACERO / STEEL

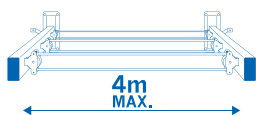

Mural Inox

REF.: 301012
ACERO INOXIDABLE/ STAINLESS STEEL

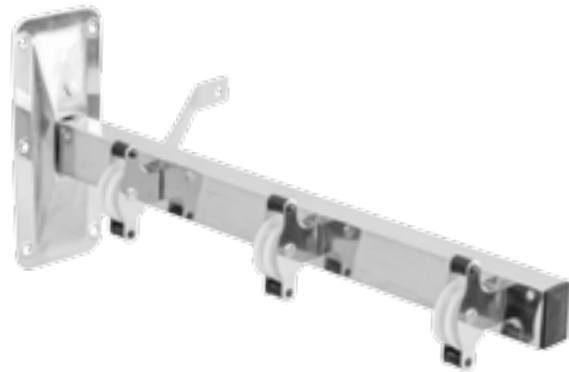

Universal balcón

REF.: 301013
ACERO GALVANIZADO / GALVANISED STEEL



	REF.	EAN	
Mural epoxi	301011	8412585110012	6
Mural Inox	301012	8412585120028	6
Universal balcón	301013	8412585110111	6



TENDIDO/DRYING

Tezno-techo extensible

REF.: 301029

ALUMINIO ANODIZADO / ALUMINIUM

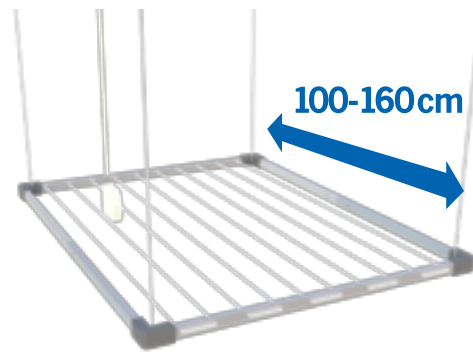

TENDIDO / DRYING

Tezno-techo manivela

REF.: 301051

ALUMINIO ANODIZADO / ALUMINIUM

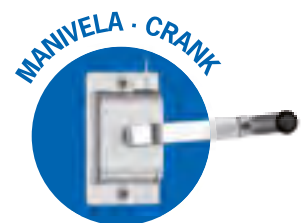
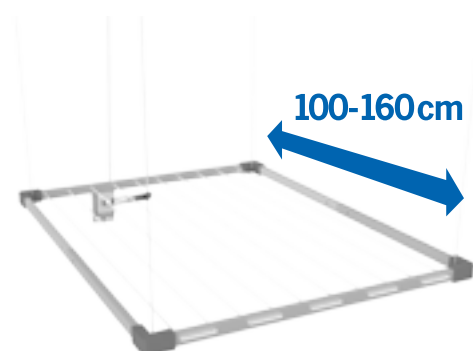

	REF.	EAN	Ⓜ	Ⓜ
Tezno-techo extensible	301029	8412585000320	100-160x78 cm	4
Tezno-techo manivela	301051	8412585002768	100-160x78 cm	4

Único

REF.: 301039

ALUMINIO ANODIZADO / ALUMINIUM

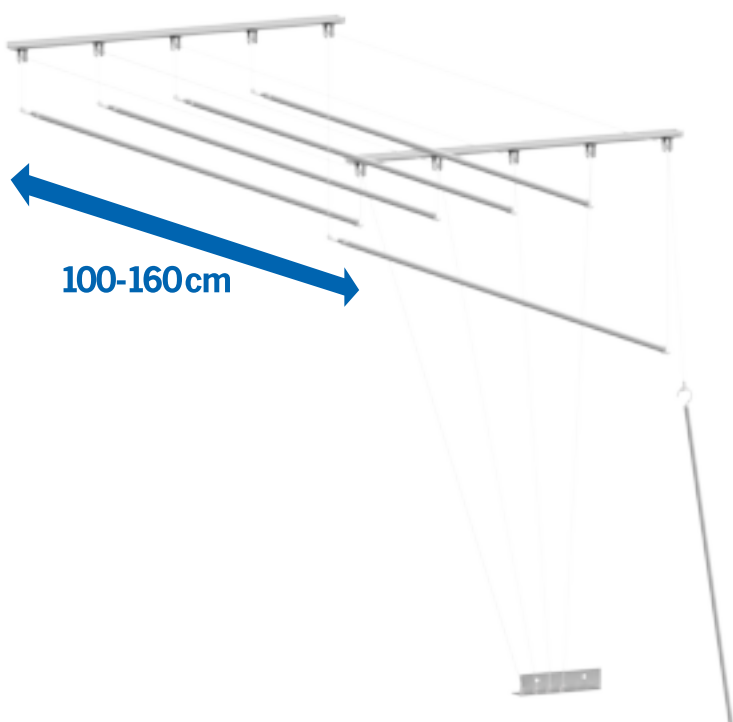

100-160cm





TENDIDO/DRYING

Jardín

REF.: 301018

ALUMINIO ANODIZADO / ALUMINIUM



	REF.	EAN		
Único	301039	8412585001860	100-160x50 cm	4
Jardín	301018	8412585000313	110x110 cm	2

Avión B2

REF.: 301052

ACERO INOX - ALUMINIO / STAINLESS STEEL-ALUMINIUM

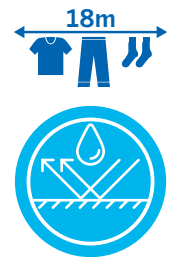
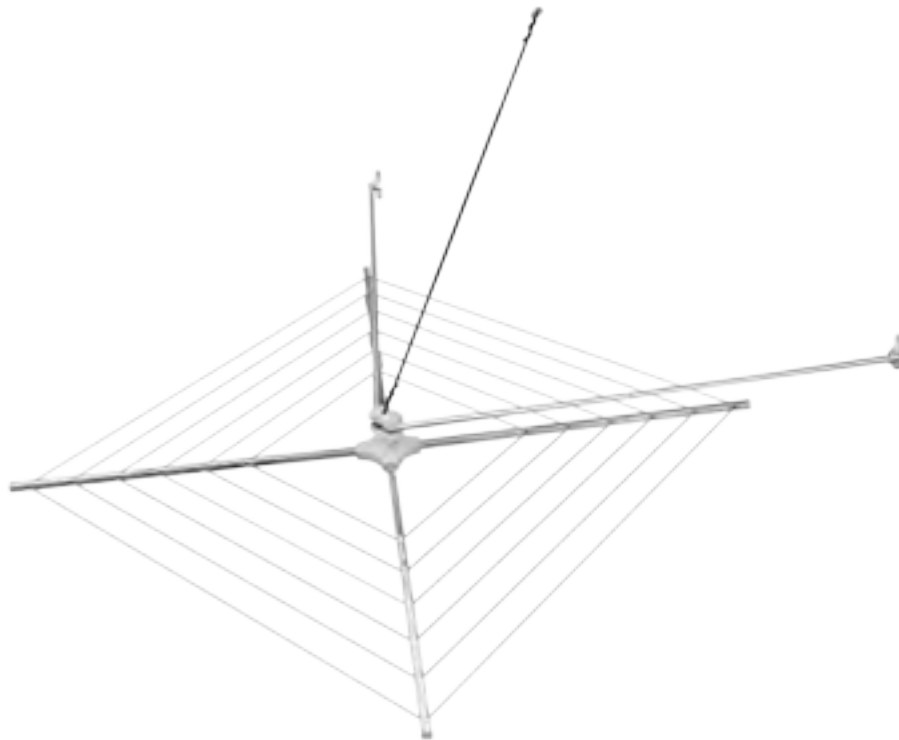

Avión B1

REF.: 301053

ACERO INOX - ALUMINIO / STAINLESS STEEL-ALUMINIUM

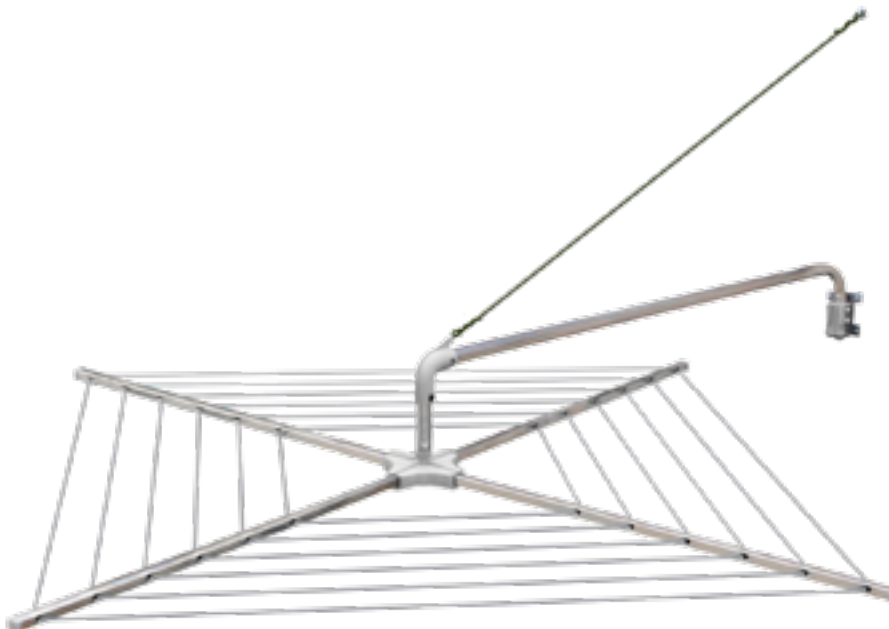

TENDIDO/DRYING

	REF.	EAN	Ⓜ	ⓧ
Avión B-2	301052	8412585002775	110x110 cm	2
Avión B1	301053	8412585002782	110x110 cm	2

Avión B1-T

REF.: 301054

ACERO INOXIDABLE / STAINLESS STEEL

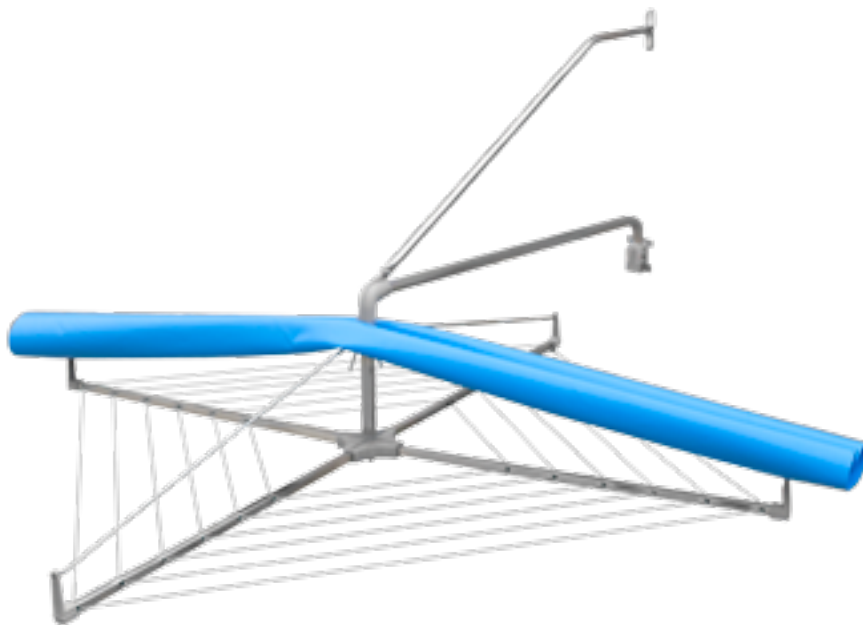

TENDIDO/DRYING

Avión matic

REF.: 301055

ACERO INOX / STAINLESS STEEL

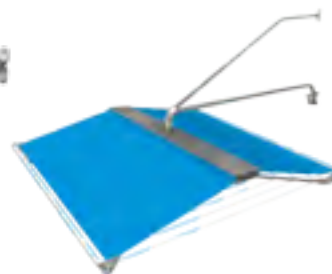

	REF.	EAN	Ⓜ	Ⓜ
Avión B1-T	301054	8412585002799	110x110cm	2
Avión matic	301055	8412585002805	110x110 cm	2

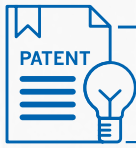

Tendedero inventado y patentado por cuncial **Dryer invented and patented by Cuncial** **1973**

Durante estos más de 60 años de andadura hemos conseguido numerosos éxitos. Uno de ellos, quizás el más reseñable, es la invención del **TZ**.

La creación de este tendedero supuso una revolución tanto dentro como fuera de Cuncial, un hecho que nos enorgullece y que nos permitió seguir creyendo en que la innovación era y es el camino.

Fue el primer tendedero fabricado en serie en España, cuya patente fue declarada, por oficio nº 7967, de utilidad en la edificación por la Dirección General de Arquitectura. De esto hace ya algunos años, pero el TZ sigue siendo el original, único e inimitable.

During these 60 years of existence we have achieved many successes. One of them, perhaps most notable, is the TZ invention.

The creation of this dryer was a revolution both within like outside Cuncial, a fact that makes us proud and allowed us to continue believing that innovation was and is the way.

It was one of the first mass-produced dryer in Spain, whose patent was declared useful in construction by the General Directorate of Architecture through official communication nº 7967. Some years have passed, but the TZ is still the original, unique and inimitable.



TZ-S-2

REF.: 102001

TZ-S-2 Blister

REF.: 103001

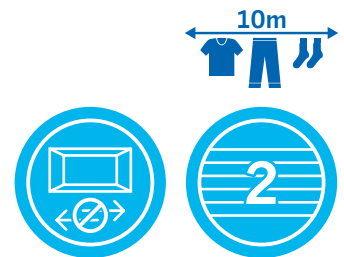

TZ-S-3

REF.: 102002

TZ-S-3 Blister

REF.: 103002

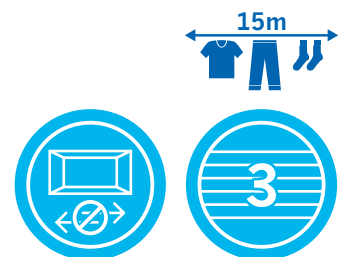



TZ-S-4

REF.: 102003

TZ-S-4 Blister

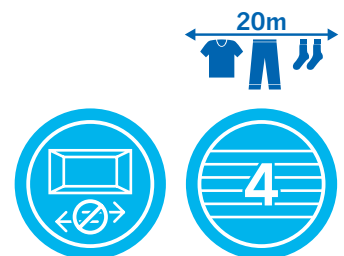
REF.: 103003



	REF.	EAN	
TZ-S2	102001	8412585002003	9/25
TZ-S2 Blister	103001	8412585020021	9
TZ-S3	102002	8412585003000	9/25
TZ-S3 Blister	103002	8412585000037	9
TZ-S4	102003	8412585004007	9/25
TZ-S4 Blister	103003	8412585040043	9

Premier-2 TZ

REF: 104002

Premier-2 TZ Blister

REF: 105002

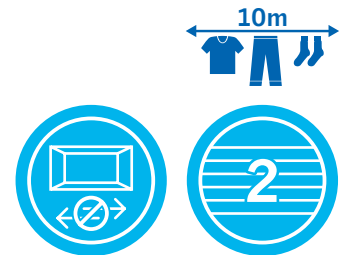

Premier-3 TZ

REF: 104003

Premier-3 TZ Blister

REF: 105002

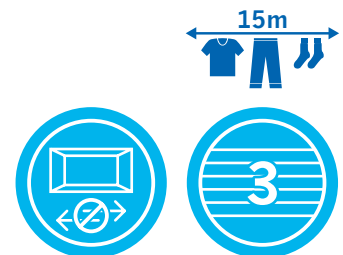

Premier-4 TZ

REF: 104004

Premier-4 TZ Blister

REF: 105004

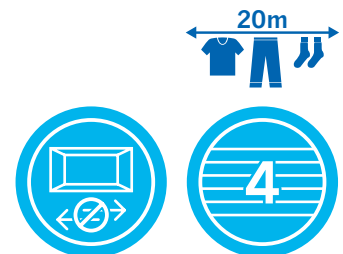







TENDIDO/DRYING

	REF.	EAN	
Premier-2 TZ	104002	8412585000054	25
Premier-2 TZ Blister	105002	8412585000597	9
Premier-3 TZ	104003	8412585000061	25
Premier-3 TZ Blister	105003	8412585000603	9
Premier-4 TZ	104004	8412585000047	25
Premier-4 TZ Blister	105004	8412585000610	9

AC Epoxi



ACERO / STEEL

<p>80 80x23x71cm REF: 311015</p>	<p>4m</p> 	<p>100 100x23x71cm REF: 311016</p>	<p>5m</p> 
<p>120 120x23x71cm REF: 311017</p>	<p>6m</p> 	<p>140 140x23x71cm REF: 311018</p>	<p>7m</p> 
<p>150 150x23x71cm REF: 311022</p>	<p>7,5m</p> 	<p>160 160x23x71cm REF: 311019</p>	<p>8m</p> 
<p>180 180x23x71cm REF: 311020</p>	<p>9m</p> 		



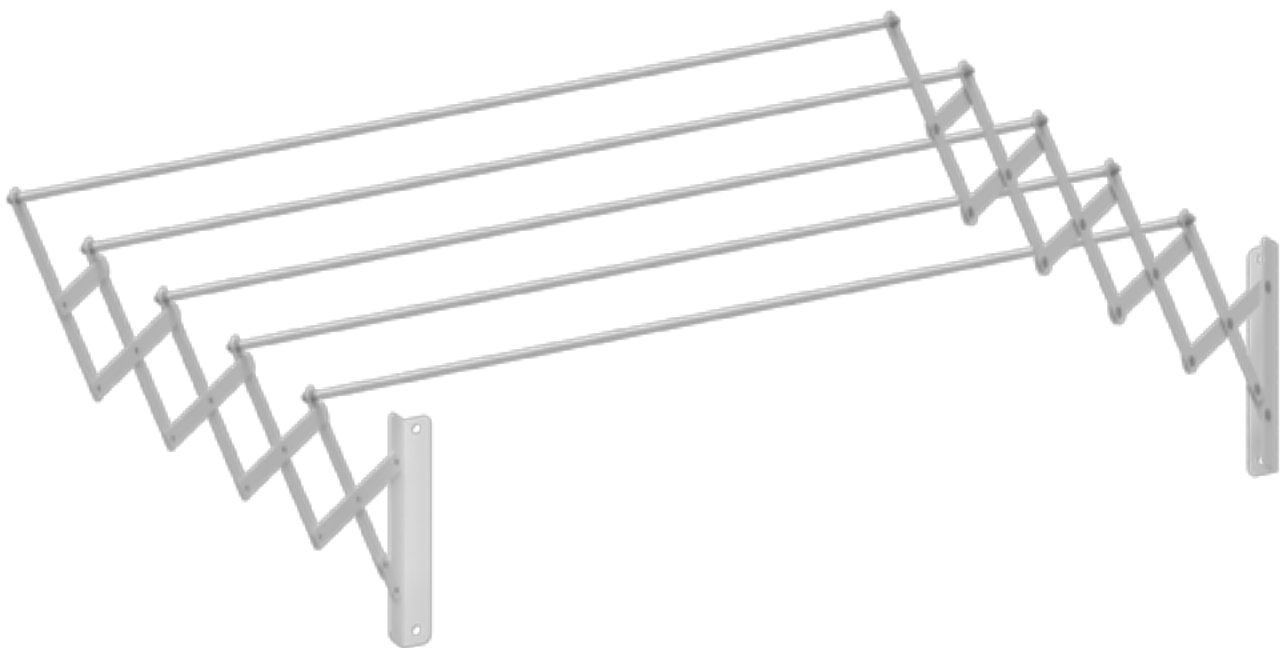





TENDIDO / DRYING



	REF.	EAN		
AC-80-EPOXI	311015	8412585000016	80x23x71 cm	5
AC-100-EPOXI	311016	8412585000023	100x23x71 cm	5
AC-120-EPOXI	311017	8412585000115	120x23x71 cm	5
AC-140-EPOXI	311018	8412585000146	140x23x71 cm	5
AC-150-EPOXI	311022	8412585000801	150x23x71 cm	5
AC-160-EPOXI	311019	8412585000139	160x23x71 cm	5
AC-180-EPOXI	311020	8412585000528	180x23x71 cm	5

AC Aluminio



ALUMINIO ANODIZADO / ALUMINIUM

<p>80 80x23x71cm REF.: 301120</p>	<p>4m</p> 	<p>100 100x23x71cm REF.: 301121</p>	<p>5m</p> 
<p>120 120x23x71cm REF.: 301122</p>	<p>6m</p> 	<p>140 140x23x71cm REF.: 301123</p>	<p>7m</p> 
<p>160 160x23x71cm REF.: 301124</p>	<p>8m</p> 	<p>180 180x23x71cm REF.: 301125</p>	<p>9m</p> 



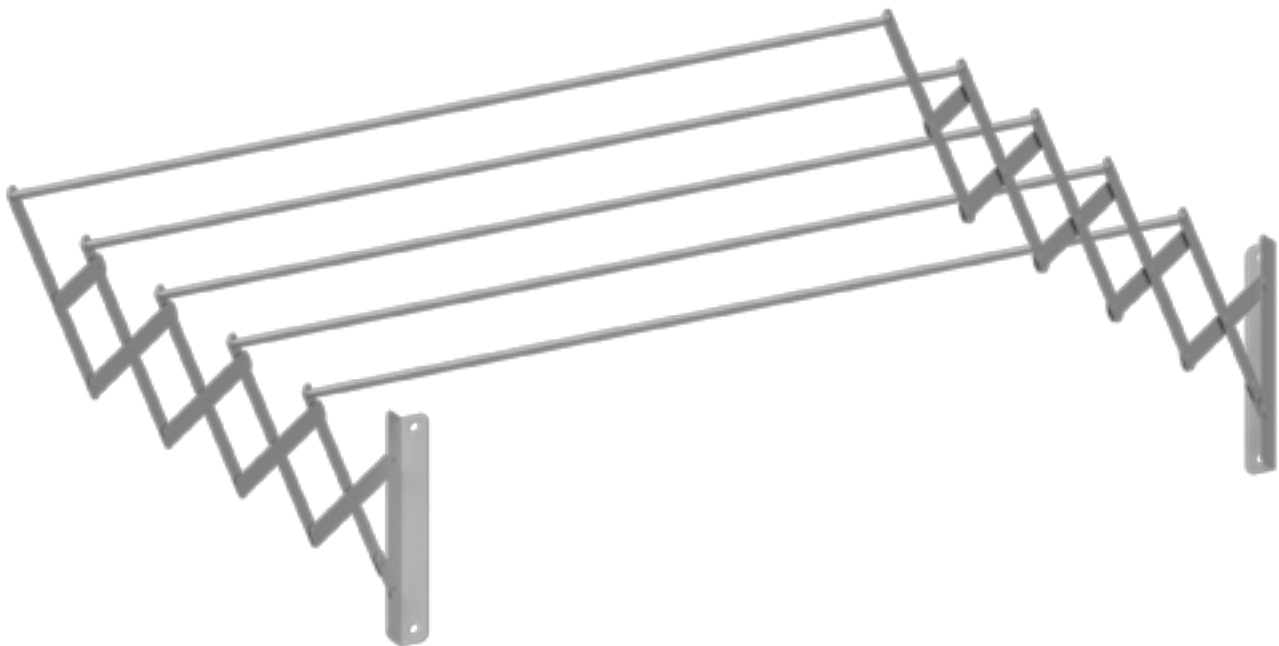



TENDIDO/DRYING

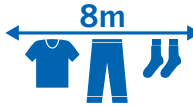

	REF.	EAN		
AC-80-Aluminio	301120	8412585200010	80x23x71 cm	3
AC-100-Aluminio	301121	8412585200027	100x23x71 cm	3
AC-120-Aluminio	301122	8412585200041	120x23x71 cm	3
AC-140-Aluminio	301123	8412585200065	140x23x71 cm	3
AC-160-Aluminio	301124	8412585200089	160x23x71 cm	3
AC-180-Aluminio	301125	8412585200096	180x23x71 cm	3

AC Winny

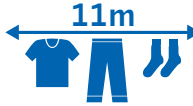
ALUMINIO ANODIZADO / ALUMINIUM

80	84x21x65cm REF.: 301030		100	104x21x65cm REF.: 301031	
120	124x21x65cm REF.: 301032		140	144x21x65cm REF.: 301033	
160	164x21x65cm REF.: 301034				



FIJO O EXTRAIBLE
FIXED OR REMOVABLE

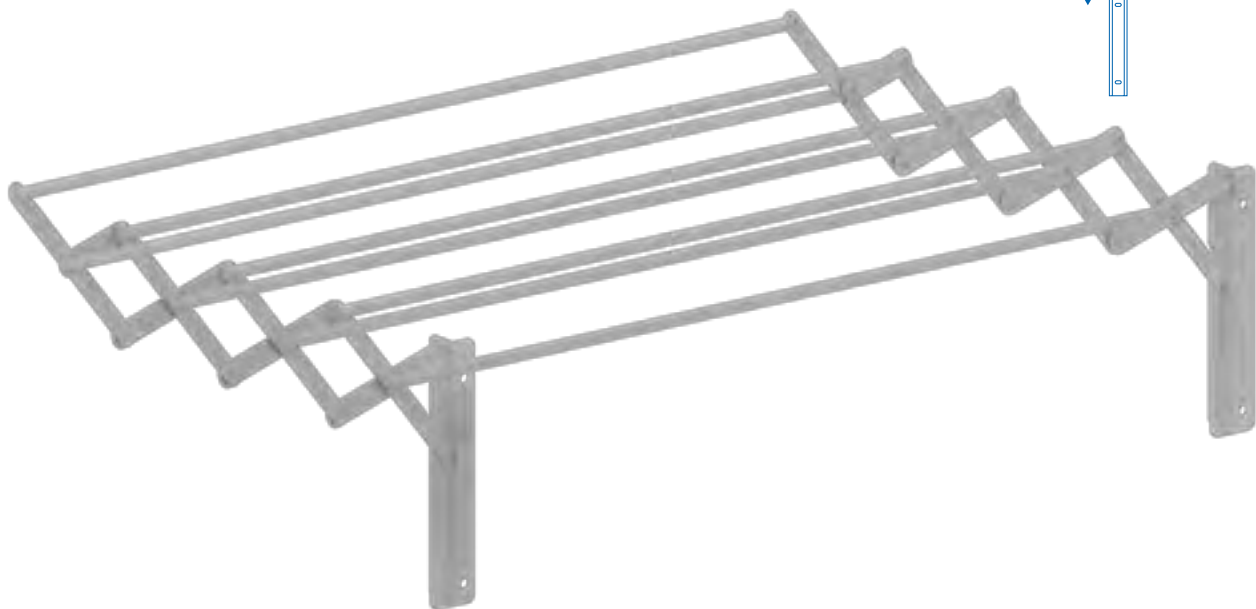
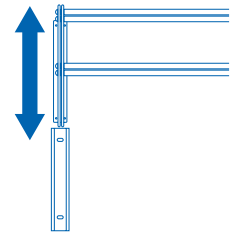



Juego extra de pletinas

REF.: 301038



ALUMINIO ANODIZADO / ALUMINIUM



	REF.	EAN		
AC-WINNY 8-80	301030	8412585000337	84x21x65 cm	3
AC-WINNY 8-100	301031	8412585000344	104x21x65 cm	3
AC-WINNY 8-120	301032	8412585000351	124x21x65 cm	3
AC-WINNY 8-140	301033	8412585000368	144x21x65 cm	3
AC-WINNY 8-160	301034	8412585000658	164x21x65 cm	3
Jego extra de pletinas	301038	8412585000948	---	?

AC Compact Aluminio

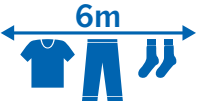
ALUMINIO ANODIZADO / ALUMINIUM

80 80x21x43cm REF.: 301115  **120** 120x21x43cm REF.: 301117 
100 100x21x43cm REF.: 301116 

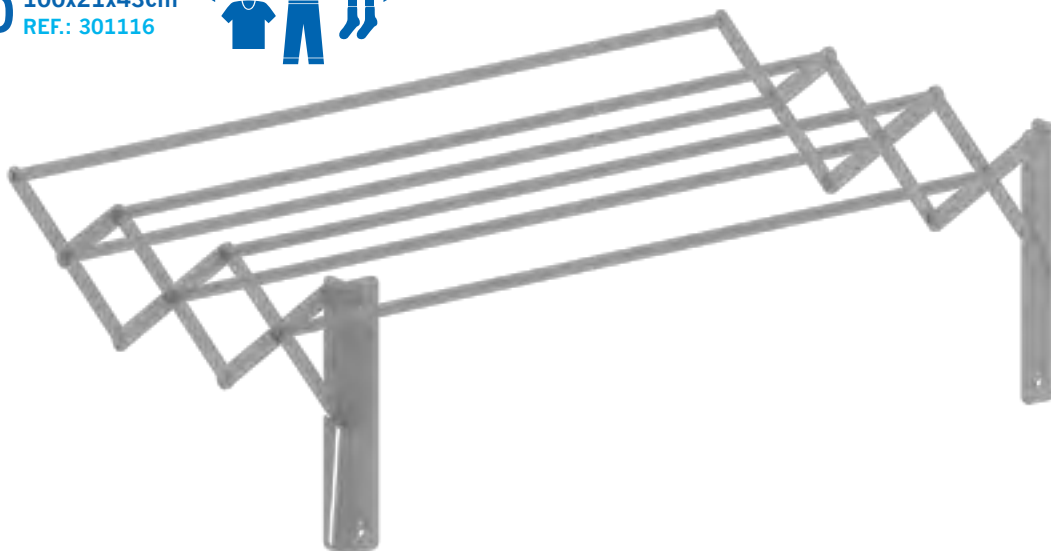

TENDIDO/DRYING

Telesmart

ALUMINIO ANODIZADO / ALUMINIUM

50 49x20x41cm REF.: 301126  **70** 70x20x41cm REF.: 301127 

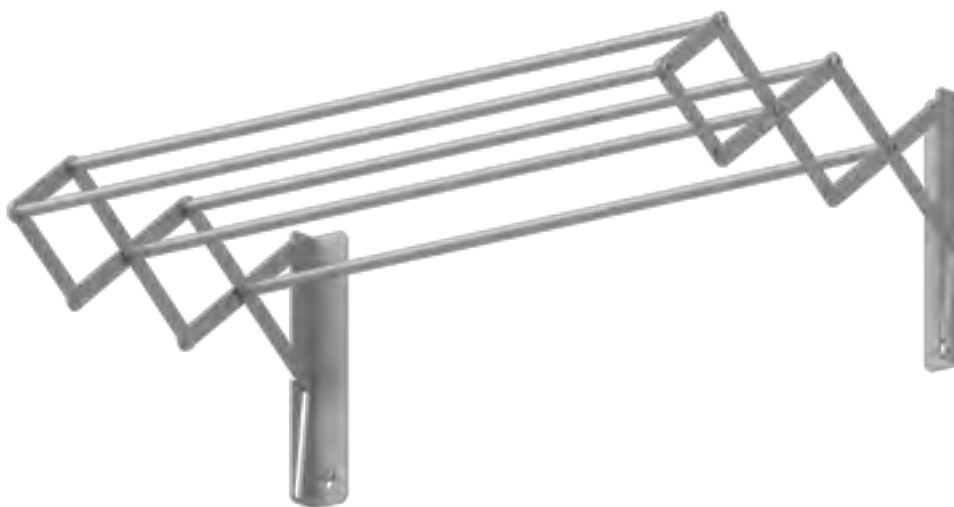

	REF.	EAN	Ⓜ	📦
AC-Compact-80 Aluminio	301115	8412585002829	80x21x43 cm	3
AC-Compact-100 Aluminio	301116	8412585002836	100x21x43 cm	3
AC-Compact-120 Aluminio	301117	8412585002843	120x21x43 cm	3
Telesmart 50	301126	8412585002966	49x20x41 cm	6
Telesmart 70	301127	8412585002973	70x20x41 cm	6

PZ-PP-70

REF.: 201001



70mm
x24



PZ Plástico extra

REF.: 201008



75mm
x24



PZ-PP-80

REF.: 201002



83mm
x20



PZ-MAD-80

REF.: 201003





FSC
75mm
x24



PZ-BI-INYEC

REF.: 201004



 82mm
 x12



PZ-BI-mini

REF.: 201006







 70mm
 x20





Pinza monoblock

REF.: 201009





 73mm
 x24



	REF.	EAN		
PZ-PP-70	201001	8412585000641	70x10x14 mm	30
PZ plástico extra	201008	8412585002539	100x23x71 mm	30
PZ-PP-80	201002	8412585000672	83x12x19 mm	30
PZ-MAD-80	201003	8412585000832	75x10x19 mm	30
PZ-BI-INYEC	201004	8412585000849	82x12x29 mm	30
PZ-BI-mini	201006	8412585001761	70x12x24 mm	30
Pinza monoblock	201009	8412585002898	73X20X10 mm	30

Cestillo 36 pinzas

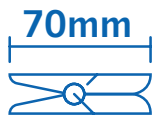
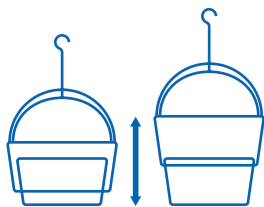
REF.: 201005



x36

Tendedor 16 pinzas

REF.: 701018



TENDIDO/DRYING

Cubre lluvia

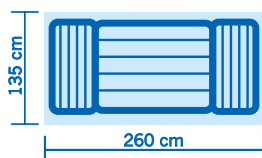

REF.: 701009

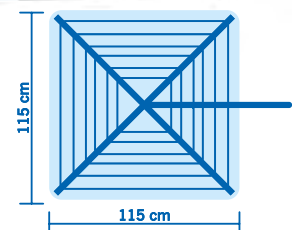
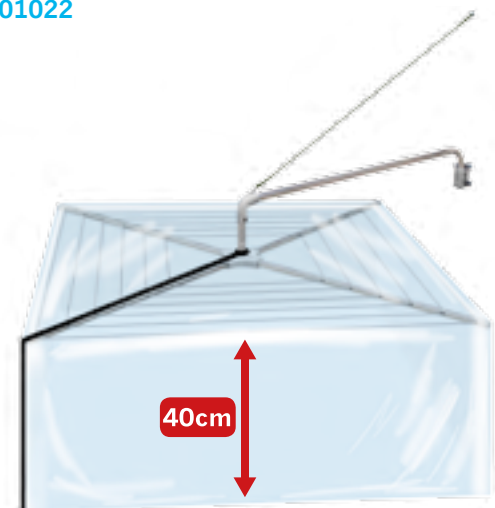

Cubre lluvia avión

REF.: 701022



	REF.	EAN		
Cestillo 36 pinzas	201005	8412585000993	20x20 cm	12
Tendedor 16 pinzas	701018	8412585001167	29x29x33 cm	12
Cubre lluvia	701009	8412585001082	135X260 cm	10
Cubre lluvia avión	701022	8412585002812	115x115x40 cm	6

Cuerda alma de acero

20m REF.: 201012 30m REF.: 201013



CON DOS TENSORES
TWO TENSOR INCLUDED

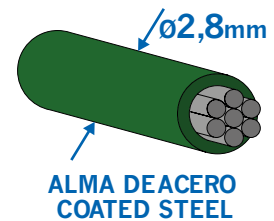

Cuerda alma de nylon

20m REF.: 201014 30m REF.: 201015



CON UN TENSOR
ONE TENSOR INCLUDED

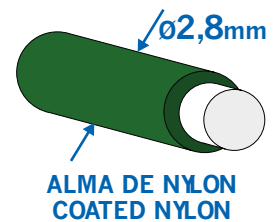

Conector-tensor para cuerda

REF.: 201016



	REF.	EAN	
Cuerda alma de acero 20m	201012	8412585002546	15
Cuerda alma de acero 30m	201013	8412585002553	15
Cuerda alma de nylon 20m	201014	8412585002560	15
Cuerda alma de nylon 30m	201015	8412585002577	15
Conector-tensor para cuerda	201016	8412585002942	20

TENDIDO/DRYING

Mini

REF.: 501009



Nova

REF.: 501008

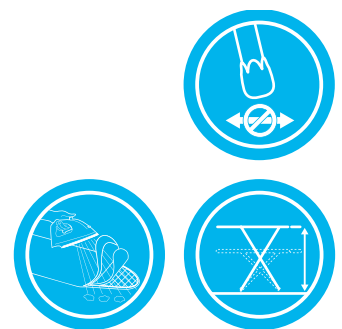

PLANCHADO/IRONING

	REF.	EAN	Ⓜ	Ⓜ
Mini	501009	8412585002720	74x30 cm	4
Nova	501008	8412585002737	105X32 cm	6

Classica

REF.: 501001

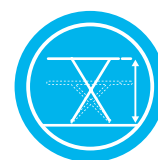
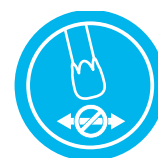

Atenea

REF.: 501005

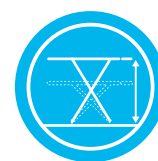

PLANCHADO/IRONING

	REF.	EAN	Ⓜ	Ⓜ
Classica	501001	8412585000443	110x32 cm	4
Atenea	501005	8412585001945	120x38 cm	4

Selena

REF.: 501013

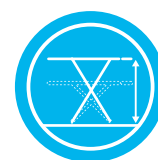
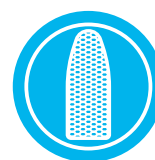

Electra colors

REF.: 501015

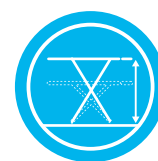
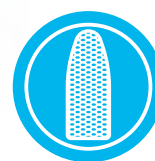

PLANCHADO/IRONING

	REF.	EAN	Ⓜ	Ⓜ
Selena	501013	8412585002614	110x33 cm	4
Electra Colors	501015	8412585002638	120x38 cm	4

Magna

REF.: 501012



ENCHUFE ALARGADOR
EXTENSION PLUG

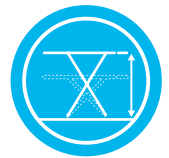
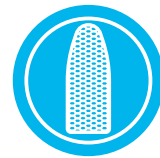

PLANCHADO/IRONING

	REF.	EAN	Ⓜ	Ⓜ
Magna	501012	8412585000931	120x45 cm	2

Funda algodón

REF.: 000003

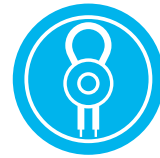
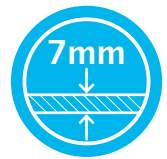
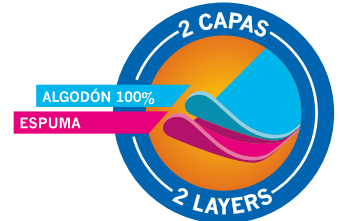
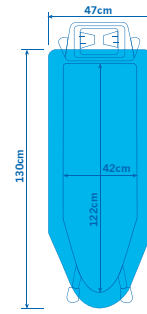

PLANCHADO/IRONING

Funda muletón

REF.: 000004

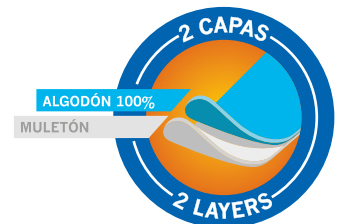
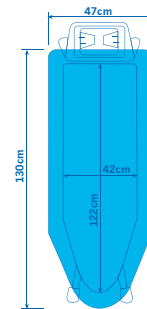

	REF.	EAN	Ⓜ	Ⓜ
Funda algodón	000003	8412585000962	130x47 cm	12
Funda muletón	000004	8412585000979	130x47 cm	12

Funda muletón colors line

REF.: 000005

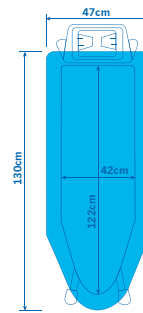
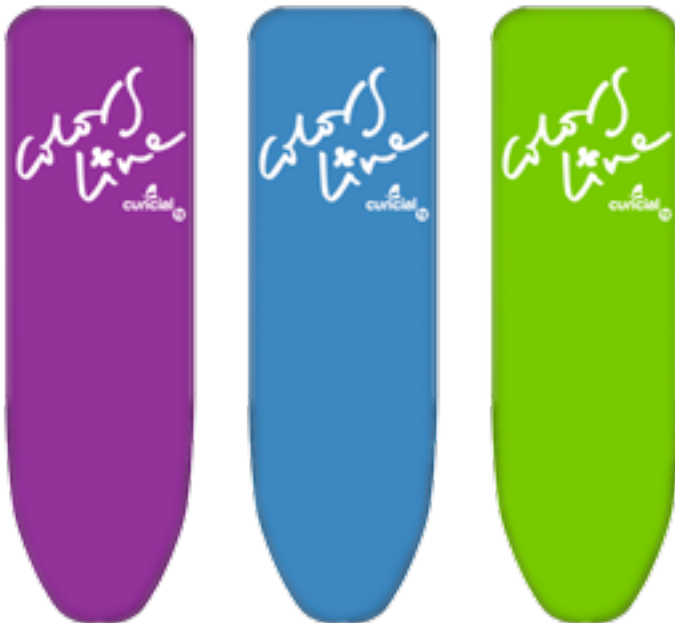

ALGODÓN 100%
MULETÓN

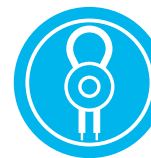
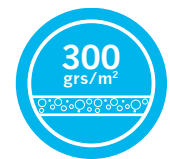

PLANCHADO/IRONING

Funda titanium

REF.: 700007

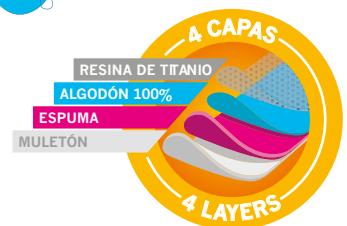
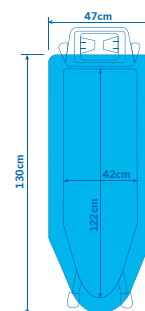

RESINA DE TITANIO
ALGODÓN 100%
ESPUMA
MULETÓN

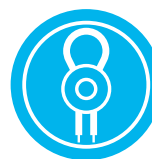
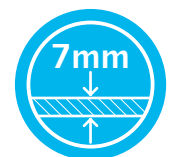

	REF.	EAN	Ⓜ	Ⓜ
Funda muletón colros line	000005	8412585002744	130x47 cm	12
Funda titanium	700007	8412585002959	130x47 cm	12

Paño sobre tabla

REF.: 701008



Paño sobre mesa

REF.: 701013



PLANCHADO/IRONING



Soporte plancha

REF.: 701019



Soporte plancha luxe

REF.: 701020

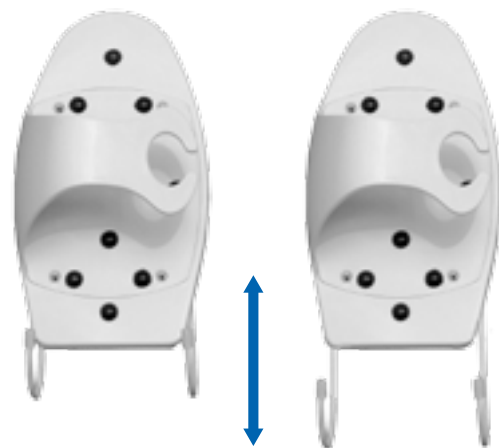

	REF.	EAN	Ⓜ	📦
Paño sobre tabla	701008	8412585001075	110x110 cm	12
Paño sobre mesa	701013	8412585001129	110x110 cm	12
Sorporte plancha	701019	8412585001952	..	6
Soporte plancha luxe	701020	8412585001969	..	12

Plancha mangas

REF.: 701017

ACERO INOXIDABLE / STAINLESS STEEL



Suela plancha

REF.: 701011

ACERO INOXIDABLE / STAINLESS STEEL



PLANCHADO/IRONING

Base silicona

REF.: 701021

ACERO INOXIDABLE / STAINLESS STEEL

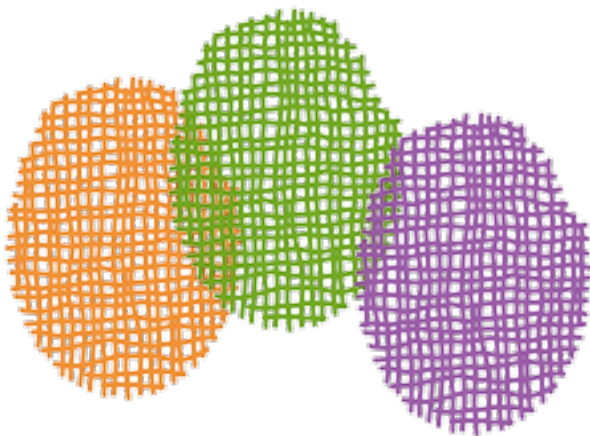

COLOR OPTIONS



Descalcificador

REF.: 701014

Limpia planchas

REF.: 701015



	REF.	EAN	Ⓜ	Ⓜ
Plancha mangas	701017	8412585001150	52x51cm	12
Suela plancha	701011	8412585001105	110x110 cm	12
Base silicona	701021	8412585002683	27x19,5 cm	12
Descalcificador	701014	8412585001136	..	12
Limpia planchas	701015	8412585001143	..	12

Saco-malla lavado

45X25cm **70X50cm** **90X60cm**
 REF.: 701003 REF.: 701004 REF.: 701005



Malla calzado

REF.: 701010



COMP. LAVADO/WASHING ACCESSORIES

Malla lencería

REF.: 701007



Cesto ropa

REF.: 604024



	REF.	EAN	Ⓜ	📦
Saco-malla lavado 45X25	701003	8412585001020	45x25 cm	12
Saco-malla lavado 70X50	701004	8412585001037	70x50 cm	12
Saco-malla lavado 90X60	701005	8412585001044	90x60 cm	12
Malla calzado	701010	8412585001099	30x20x15 cm	12
Malla lencería	701007	8412585001068	18x23x2 cm	12
Cesto ropa	604024	8412585001402	45x45x48 cm	12

Funda lavadora carga superior

REF.: 701001



Funda lavadora carga frontal

REF.: 701002



COMP. LAVADO/WASHING ACCESSORIES

Funda aire acondicionado

REF.: 701016



	REF.	EAN	Ⓜ	⚡
Funda lavadora carga superior	701001	8412585001006	80x51,5x73 cm	6
Funda lavadora carga frontal	701002	8412585001013	78x58 cm	6
Funda aire acondicionado	701016	8412585001938	88x55,5x31 cm	6

Armario

Pequeño Mediano Grande
REF.: 604001 REF.: 604002 REF.: 604003



ORDENACIÓN/HOME STORAGE

Perchero

Simple Doble Piramidal
REF.: 604027 REF.: 604028 REF.: 604029



	REF.	EAN	Ⓜ	📦
Armario pequeño	604001	8412585001174	70x46x156 cm	4
Armario mediano	604002	8412585001181	90x46x158 cm	4
Armario grande	604003	8412585001198	98x46x175 cm	4
Perchero simple	604027	8412585001433	97-175x88x43 cm	4
Perchero doble	604028	8412585001440	97-175x88x43 cm	4
Perchero piramidal	604029	8412585001457	156x77-143x59 cm	4

Cuelga escobas

REF.: 604042



Colgador sobre puertas

REF.: 604049



ORDENACIÓN/HOME STORAGE

Colgador puerta doble

REF.: 604050



	REF.	EAN	Ⓜ	Ⓜ
Cuelga escobas	604042	8412585001914	70x46x156 cm	6
Colgador sobre puertas	604049	8412585002522	90x46x158 cm	6
Colgador puerta doble	604050	8412585002584	98x46x175 cm	4

Org. Cajones

30X30
REF.: 604044



15,5X30
REF.: 604045



10,5X30
REF.: 604046



Org. Cajones octogonal

REF.: 604043



FÁCIL AJUSTE
EASY ADJUST

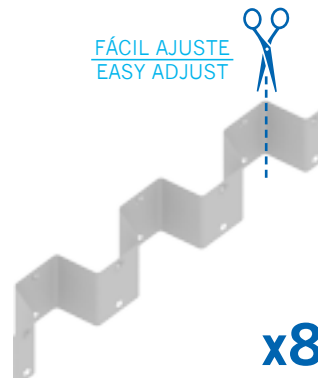

x8

Funda vacío

55X90
REF.: 604039



74X13
REF.: 604040



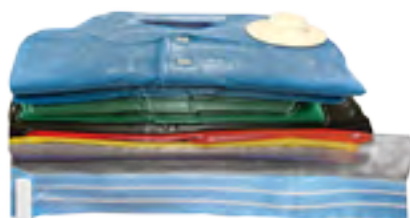

90X130
REF.: 604041



-75% vol.



	REF.	EAN		
Org. Cajones 30X30	604044	8412585001976	30x30 cm	12
Set 2 org. Cajones 15,5X30	604045	8412585001983	15,5x30 cm	12
Set 3 org. Cajones 10,5X30	604046	8412585001990	10,5x30 cm	12
Org. cajones octogonal	604043	8412585001921	55 x90 cm	6
Set 2 funda vacío 55X90	604039	8412585001884	55x90 cm	6
Funda vacío 74X13	604040	8412585001891	74x13 cm	6
Funda vacío 90X130	604041	8412585001907	90x130 cm	6

Zapatero 20 pares

REF.: 604025



Horma botas

REF.: 604048



x4

ORDENACIÓN/HOME STORAGE

Horma zapatos

Masculinos Femeninos

REF.: 604051

REF.: 604052



x2

	REF.	EAN	Ⓜ	📦
Zapatero 20 pares	604025	8412585001419	93x20x67 cm	6
Set 2 pares horma botas	604048	8412585002515	..	6
Horma zapatos masculinos	604051	8412585002591	..	6
Horma zapatos femeninos	604052	8412585002607	..	6

Pack 5 perchas

REF.: 801001



Pack 3 perchas blancas

REF.: 801019



1 Percha traje

REF.: 801007



ORDENACIÓN/HOME STORAGE

	REF.	EAN	
Pack 5 perchas	801001	8412585001464	12
Pack 3 perchas	801019	8412585002980	12
Percha traje	801007	8412585001525	12

Pack 3 perchas falda

REF.: 801006

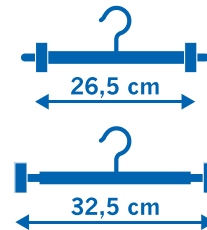

1 Percha blusa, falda

REF.: 801008



Pack 3 perchas pantalón

REF.: 801005



	REF.	EAN	
Pack 3 perchas falda	801006	8412585001518	12
Percha blusa, falda	801008	8412585001532	12
Pack 3 perchas pantalón	801005	8412585001501	12



ORDENACIÓN/HOME STORAGE

Pack 10 perchas alambre

REF.: 801018

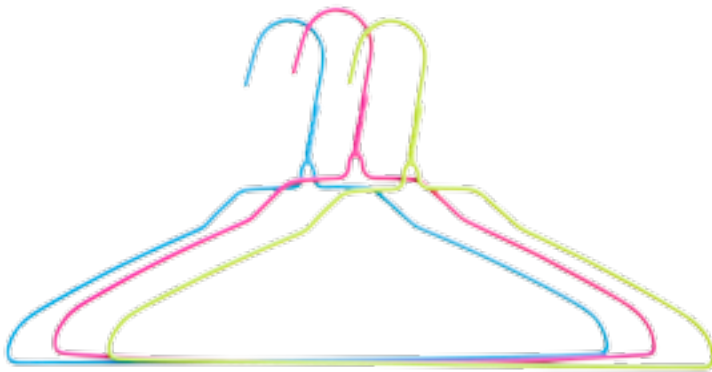

Pack 10 perchas plástico

REF.: 801003

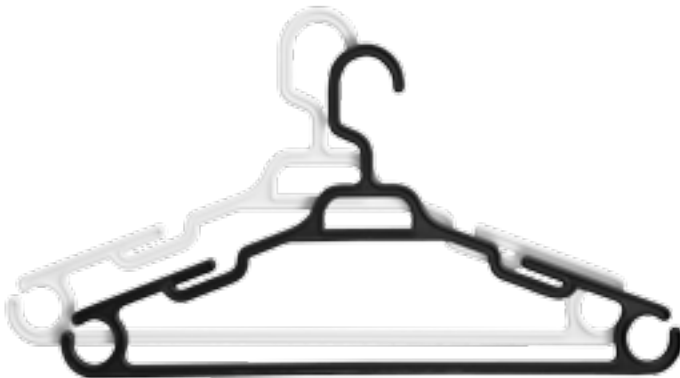

Pack 3 perchas ropa delic.

REF.: 801011



ORDENACIÓN/HOME STORAGE

	REF.	EAN	
Pack 10 perchas alambre	801018	8412585001631	12
Pack 10 perchas plástico	801003	8412585001488	12
Pack 3 perchas ropa delic.	801011	8412585001563	12

1 Percha falda, pantalón

REF.: 801016



1 Percha falda, pant. 4 altur.

REF.: 801017

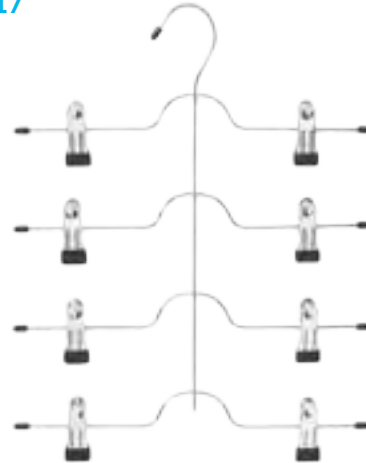

1 Percha cinturones

REF.: 801015



1 Percha corbatas

REF.: 801014

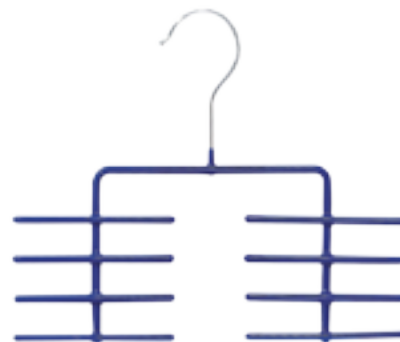

1 Percha 4 pantalones

REF.: 801013

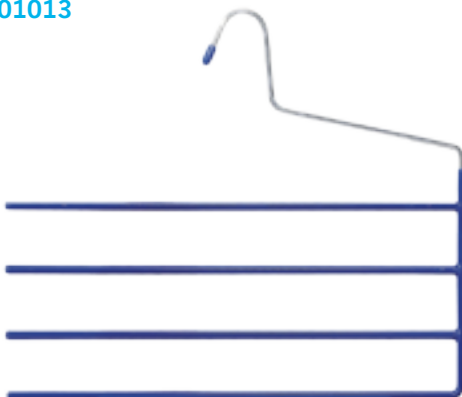

ORDENACIÓN/HOME STORAGE

	REF.	EAN	
Percha falda pantalón	801016	8412585001617	10
Percha falda,pant. 4 altur.	801017	8412585001624	10
Percha cinturones	801015	8412585001600	10
Percha corbatas	801014	8412585001594	10
Percha 4 pantalones	801013	8412585001587	12

Botellero 2

REF.: 410012

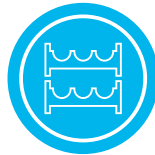

Botellero 4

REF.: 410013



Botellero 6

REF.: 410015



Botellero 6 rústico

REF.: 410014



MENAJE/KITCHEN

	REF.	EAN	Ⓜ	📦
Botellero 2	410012	8412585003123	21x20,5x245 cm	12
Botellero 4	410013	8412585003093	39,7x25x13 cm	12
Botellero 6	410015	8412585003116	58x25x14,5 cm	10
Botellero 6 rústico	410014	8412585003109	58,5x31x13,5 cm	12

Multibasket

3 Alturas

REF.: 410029



Multibasket

4 Alturas

REF.: 410030





MENAJE/KITCHEN

Cesto de multibasket

REF.: 410031



	REF.	EAN		
Multibasket 3 alturas	410029	8412585002904	42x31x66 cm	5
Multibasket 4 alturas	410030	8412585002911	42x31x88 cm	4
Cesto de multibasket	410031	8412585002935	39,5x31x12 cm	6













+60 años al cuidado de tu ropa

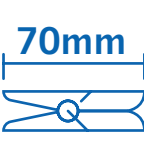

Tendido/Drying

	Medidas	Measurements
	Mesures	Medidas
	Unidades en embalaje	Units in packaging
	Unités dans l'emballage	Unidades na embalagem
	Metros de tendido	Laying meters
	longueur d'étendage	Deitando metros
	Varillas Ø6mm	Rod Ø6mm
	Tige Ø6mm	Vareta Ø6mm
	Varillas remachadas	Riveted rod
	Tiges rivetées	Varetas rebitadas
	Acero enresinado	Coiled steel
	Acier enroulé	Aço enrolado
	Elementos antideslizantes	Anti-slip element
	Patins antidérapants	Elemento antideslizante
	Elementos antideslizantes	Anti-slip element
	Patins antidérapants	Elemento antideslizante
	Elementos antideslizantes	Anti-slip element
	Patins antidérapants	Elemento antideslizante
	Elementos antideslizantes	Anti-slip element
	Patins antidérapants	Elemento antideslizante
	Elementos antideslizantes	Anti-slip element
	Patins antidérapants	Elemento antideslizante

Tendido/Drying

	Totalmente inoxidable	Totally stainless
	Totalement Inoxydable	Totalmente inoxidável
	Pata plegable	Folding leg
	Jambe pliante	Pernas desdobráveis
	Apto para bañeras	Suitable for bathtubs
	Adapté à la baignoire	Apropriado para banheira
	Ideal para ropa delicada	Ideal for delicate clothes
	Idéal pour les vêtements délicats	Ideal para roupas delicadas
	Apto para interior/exterior	Suitable for indoor and outdoor
	Adapté pour intérieur et extérieur	Adequado para interior e exterior
	Líneas de tendido	Laying lines
	Lignes de d'étendage	Linhas de postura
	Sistema de bloqueo individual	Individual locking system
	Système de verrouillage individuel	sistema de travamento individual
	Tamaño Cantidad	Size Quantity
	Taille Quantité	Tamanho Quantidade
	Certificado FSC	FSC certificate
	FSC certificat	FSC certificado
	Elementos antideslizantes	Anti-slip element
	Patins antidérapants	Elemento antideslizante
	Elementos antideslizantes	Anti-slip element
	Patins antidérapants	Elemento antideslizante

Planchado/Ironing

KEY INDEX

Planchado/Ironing



Elementos antideslizantes Anti-slip element
Patins antidérapants Elemento antideslizante



Altura regulable Adjustable height
Hauteur réglable Altura regulável



Rejilla Mesh
Grille Grade



Rejilla monoblock Monoblock mesh
Grille monobloc Grade monoblock



Ideal para ropa delicada Ideal for delicate clothes
Idéal pour les vêtements délicats Ideal para roupas delicadas



Resistente altas temperaturas High temperature resistant
Résistante à haute température Resistente a altas temperaturas

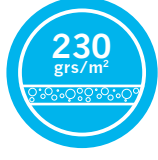

230 g/m² Densidad Muletón Molleton density
Densité molleton Densidade moletão

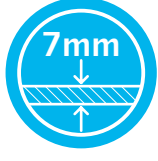

7mm Espesor Foam Foam thickness
Épaisseur de mousse Espessura da espuma



ALGODÓN 100% COTTON Algodón Cotton
Coton Algodão

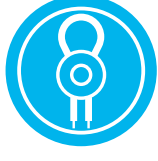

Elementos de ajuste Adjustment elements
Éléments de réglage Elementos de fixação



Cierre cremallera Zip closure
Fermeture à glissière Fecho de correr

Compl. lavado/Washing accessories

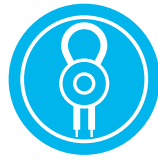

Elementos de ajuste Adjustment elements
Éléments de réglage Elementos de fixação



Ideal para ropa delicada Ideal for delicate clothes
Idéal pour les vêtements délicats Ideal para roupas delicadas



Valido varias alturas Suitable for various heights
Adapté à différentes hauteurs Adequado para várias alturas



Rotable Rotable
Rotatif Rotativo



Ideal para ropa delicada Ideal for delicate clothes
Idéal pour les vêtements délicats Ideal para roupas delicadas



Cierre cremallera Zip closure
Fermeture à glissière Fecho de correr



Cantidad de cajones Number of drawers
Quantité de caisses Número de gavetas



Cantidad de bolsas Number of bags
Nombre de sacs Número de malas

Menaje/Kitchen



Apilable Stackable
Empilable Empilhável



KEY INDEX



www.cuncial.es

AVDA. DE LA RIOJA, 20 • 01330 • LABASTIDA (ÁLAVA)
Tel.: +34 945 33 10 17 - +34 945 33 11 80 • Fax: +34 945 33 14 04
cuncial@cuncial.es

